



# DFS60E-S4CM01000

DFS60

INCREMENTAL ENCODERS

**SICK**  
Sensor Intelligence.

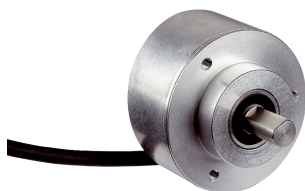

Illustration may differ



### Ordering information

Type	Part no.
DFS60E-S4CM01000	1069962

Other models and accessories → [www.sick.com/DFS60](http://www.sick.com/DFS60)

### Detailed technical data

#### Performance

<b>Pulses per revolution</b>	1,000 <sup>1)</sup>
<b>Measuring step</b>	90° electronically/ppr
<b>Measuring step deviation at non binary number of lines</b>	± 0.2°
<b>Error limits</b>	± 0.3°

<sup>1)</sup> See maximum revolution range.

#### Interfaces

<b>Communication interface</b>	Incremental
<b>Communication Interface detail</b>	TTL / RS-422
<b>Number of signal channels</b>	6-channel
<b>Initialization time</b>	40 ms
<b>Output frequency</b>	≤ 300 kHz
<b>Load current</b>	≤ 30 mA
<b>Power consumption</b>	≤ 0.5 W (without load)

#### Electrical data

<b>Connection type</b>	Cable, 8-wire, universal, 5 m <sup>1)</sup>
<b>Supply voltage</b>	10 ... 32 V
<b>Reference signal, number</b>	1
<b>Reference signal, position</b>	90°, electric, logically gated with A and B
<b>Reverse polarity protection</b>	✓
<b>Short-circuit protection of the outputs</b>	✓ <sup>2)</sup>
<b>MTTFd: mean time to dangerous failure</b>	300 years (EN ISO 13849-1) <sup>3)</sup>

<sup>1)</sup> The universal cable connection is positioned so that it is possible to lay it without bends in a radial or axial direction.

<sup>2)</sup> Short-circuit opposite to another channel or GND permissible for maximum 30 s.

<sup>3)</sup> This product is a standard product and does not constitute a safety component as defined in the Machinery Directive. Calculation based on nominal load of components, average ambient temperature 40°C, frequency of use 8760 h/a. All electronic failures are considered hazardous. For more information, see document no. 8015532.

#### Mechanical data

<b>Mechanical design</b>	Solid shaft, face mount flange
--------------------------	--------------------------------

<sup>1)</sup> Allow for self-heating of 3.3 K per 1,000 rpm when designing the operating temperature range.

<b>Shaft diameter</b>	10 mm
<b>Shaft length</b>	19 mm
<b>Weight</b>	+ 0.3 kg
<b>Shaft material</b>	Stainless steel
<b>Flange material</b>	Aluminum
<b>Housing material</b>	Aluminum die cast
<b>Start up torque</b>	0.5 Ncm (+20 °C)
<b>Operating torque</b>	0.3 Ncm (+20 °C)
<b>Permissible shaft loading radial/axial</b>	80 N (radial) 40 N (axial)
<b>Operating speed</b>	≤ 9,000 min <sup>-1</sup> <sup>1)</sup>
<b>Moment of inertia of the rotor</b>	6.2 gcm <sup>2</sup>
<b>Bearing lifetime</b>	3.6 x 10 <sup>10</sup> revolutions
<b>Angular acceleration</b>	≤ 500,000 rad/s <sup>2</sup>

<sup>1)</sup> Allow for self-heating of 3.3 K per 1,000 rpm when designing the operating temperature range.

#### Ambient data

<b>EMC</b>	According to EN 61000-6-2 and EN 61000-6-4
<b>Enclosure rating</b>	IP67, housing side, cable connection (according to IEC 60529) IP65, shaft side (according to IEC 60529)
<b>Permissible relative humidity</b>	90 % (condensation of the optical scanning not permitted)
<b>Operating temperature range</b>	0 °C ... +85 °C
<b>Storage temperature range</b>	-40 °C ... +100 °C, without package
<b>Resistance to shocks</b>	50 g, 6 ms (according to EN 60068-2-27)
<b>Resistance to vibration</b>	20 g, 10 Hz ... 2,000 Hz (according to EN 60068-2-6)

#### Classifications

<b>ECl@ss 5.0</b>	27270501
<b>ECl@ss 5.1.4</b>	27270501
<b>ECl@ss 6.0</b>	27270590
<b>ECl@ss 6.2</b>	27270590
<b>ECl@ss 7.0</b>	27270501
<b>ECl@ss 8.0</b>	27270501
<b>ECl@ss 8.1</b>	27270501
<b>ECl@ss 9.0</b>	27270501
<b>ECl@ss 10.0</b>	27270501
<b>ECl@ss 11.0</b>	27270501
<b>ETIM 5.0</b>	EC001486
<b>ETIM 6.0</b>	EC001486
<b>ETIM 7.0</b>	EC001486
<b>UNSPSC 16.0901</b>	41112113

**Dimensional drawing** (Dimensions in mm (inch))

Face mount flange, cable connection

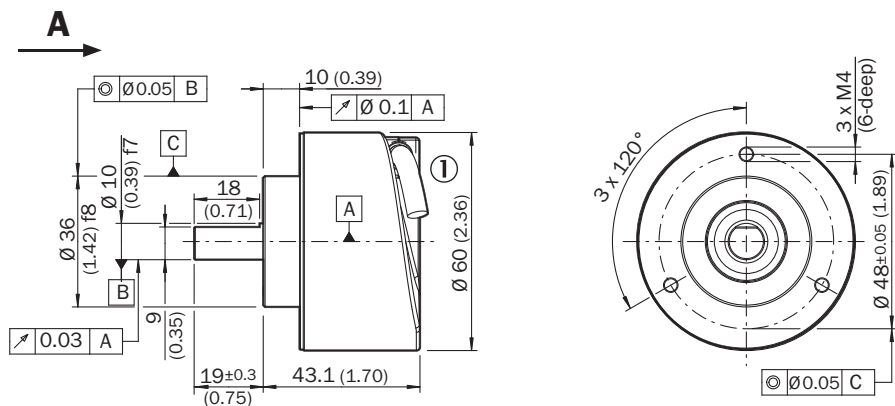

General tolerances according to DIN ISO 2768-mk

① Cable diameter = 5.6 mm +/- 0.2 mm bend radius = 30 mm

PIN assignment

**Cable, 8-wire**

View of M12 male device connector on encoder



View of M23 male device connector on encoder



PIN, 8-pin, M12 male connector	PIN, 12-pin, M23 male connector	Color of the wires for encoders with cable outlet	TTL/HTL signal	Sin/cos 1.0 V <sub>ss</sub>	Explanation
1	6	Brown	$\bar{A}$	COS-	Signal wire
2	5	White	A	COS+	Signal wire
3	1	Black	$\bar{B}$	SIN-	Signal wire
4	8	Pink	B	SIN+	Signal wire
5	4	Yellow	$\bar{Z}$	$\bar{Z}$	Signal wire
6	3	Violet	Z	Z	Signal wire
7	10	Blue	GND	GND	Ground connection of the encoder
8	12	Red	+U <sub>s</sub>	+U <sub>s</sub>	Supply voltage (volt-free to housing)
-	9	-	n.c.	n.c.	Not assigned
-	2	-	n.c.	n.c.	Not assigned
-	11	-	n.c.	n.c.	Not assigned
-	7 <sup>1)</sup>	-	0-SET <sup>1)</sup>	n.c.	Set zero pulse <sup>1)</sup>
Screen	Screen	Screen	Screen	Screen	Screen connected to housing on encoder side. Connected to ground on control side.

<sup>1)</sup> For electrical interfaces only: M, U, V, W with 0-SET function on PIN 7 on M23 male connector. The 0-SET input is used to set the zero pulse on the current shaft position. If the 0-SET input is connected to U<sub>s</sub> for longer than 250 ms after it had previously been unassigned for at least 1,000 ms or had been connected to the GND, the current position of the shaft is assigned to the zero pulse signal "Z".

### Maximum revolution range

Maximum revolution range



### Signal outputs

Signal outputs

















CW with view on the encoder shaft in direction "A", compare dimensional drawing.







Supply voltage	Output
4,5 V ... 5,5 V	TTL
10 V ... 32 V	TTL
10 V ... 32 V	HTL

**Recommended accessories**

Other models and accessories → [www.sick.com/DFS60](http://www.sick.com/DFS60)

	<b>Brief description</b>	<b>Type</b>	<b>Part no.</b>
<b>Flanges</b>			
	Flange adapter, adaptation of face mount flange with 36 mm centering hub to 50 mm servo flange, aluminum, including 3 flat head screws M4 x 10, Aluminum, including 3 countersunk screws M4 x 10	BEF-FA-036-050	2029160
	Flange adapter, adaptation of face mount flange with 36 mm centering hub to 60 mm square mounting plate, aluminum, including 3 flat head screws M4 x 8, Aluminum, including 3 countersunk screws M4 x 8	BEF-FA-036-060REC	2029162
	Flange adapter, adaptation of face mount flange with 36 mm centering hub to 58 mm square mounting plate with shock absorbers, aluminum, Aluminum	BEF-FA-036-060RSA	2029163
	Flange adapter, adaptation of face mount flange with 36 mm centering hub to 63 mm square mounting plate, aluminum, including 3 flat head screws M4 x 10, Aluminum, including 3 countersunk screws M4 x 10	BEF-FA-036-063REC	2034225
	Flange adapter, adaptation of face mount flange with 36 mm centering hub to 100 mm servo flange with 60 mm centering hub, aluminum, Aluminum	BEF-FA-036-100	2029161
<b>Mounting brackets and plates</b>			
	Mounting bracket for encoder with spigot 36 mm for face mount flange, mounting kit included	BEF-WF-36	2029164
	Mounting angle spring-loaded, for flange with centerring collar 36 mm, working temperature range -40 ° ... +120 °C, Aluminum	BEF-WF36F	4084775
<b>Other mounting accessories</b>			
	Aluminium measuring wheel with O-ring (NBR70) for 10 mm solid shaft, circumference 200 mm	BEF-MR010020R	2055224
	Aluminium measuring wheel with O-ring (NBR70) for 10 mm solid shaft, circumference 300 mm	BEF-MR010030R	2049278
	Measuring wheel with O-ring (NBR70) for 10 mm solid shaft, circumference 500 mm	BEF-MR010050R	2055227
	Aluminum measuring wheel with cross-knurled surface for 10 mm solid shaft, circumference 200 mm	BEF-MR10200AK	4084737
	Aluminum measuring wheel with smooth polyurethane surface for 10 mm solid shaft, circumference 200 mm	BEF-MR10200AP	4084738
	Aluminum measuring wheel with ridged polyurethane surface for 10 mm solid shaft, circumference 200 mm	BEF-MR10200APG	4084740
	Aluminum measuring wheel with studded polyurethane surface for 10 mm solid shaft, circumference 200 mm	BEF-MR10200APN	4084739
	Aluminum measuring wheel with cross-knurled surface for 10 mm solid shaft, circumference 500 mm	BEF-MR10500AK	4084733
	Aluminum measuring wheel with smooth polyurethane surface for 10 mm solid shaft, circumference 500 mm	BEF-MR10500AP	4084734

	Brief description	Type	Part no.
	Aluminum measuring wheel with ridged polyurethane surface for 10 mm solid shaft, circumference 500 mm	BEF-MR10500APG	4084736
	Aluminum measuring wheel with studded polyurethane surface for 10 mm solid shaft, circumference 500 mm	BEF-MR10500APN	4084735
	SICK modular measuring wheel system for face mount flange encoder with S4 mechanical design (10 mm x 19 mm solid shaft), e.g., DFS60-S4: with O-ring measuring wheel, circumference 200 mm	BEF-MRS-10-U	2085714
	Flange adapter (adapts size 60 face mount flange encoder to bearing block with part. no. 2044591)	BEF-FA-036-050-019	2063378
	Bearing block for servo and face mount flange encoder. The heavy-duty bearing block is used to absorb very large radial and axial shaft loads. Particularly when using belt pulleys, chain sprockets, friction wheels. Operating speed max. 4,000 rpm <sup>-1</sup> , axial shaft load 150 N, radial shaft load 250 N, bearing service life 3.6 x 10 <sup>9</sup> revolutions	BEF-FA-LB1210	2044591
<b>Shaft adaptation</b>			
	Bellows coupling, shaft diameter 6 mm / 10 mm, maximum shaft offset: radial ± 0.25 mm, axial ± 0.4 mm, angular +/- 4°; max. speed 10,000 rpm, -30 °C to +120 °C, max. torque 80 Ncm; material: stainless steel bellows, aluminum hub	KUP-0610-B	5312982
	Double loop coupling, shaft diameter 6 mm / 10 mm, max. shaft offset: radially +/- 2,5 mm, axially +/- 3 mm, angle +/- 10 degrees; max. speed 3.000 rpm, -30 to +80 degrees Celsius, torsional spring stiffness of 25 Nm/rad	KUP-0610-D	5326697
	Spring washer coupling, shaft diameter 6 mm / 10 mm, Maximum shaft offset: radial +/- 0.3 mm, axial +/- 0.4 mm, angular +/- 2.5°; max. speed 12,000 rpm, -10° to +80 °C, max. torque 60 Ncm; material: aluminum flange, glass fiber-reinforced polyamide membrane and hardened steel coupling pin	KUP-0610-F	5312985
	Bar coupling, shaft diameter 6 mm / 10 mm, max. shaft offset: radial ± 0,3 mm, axial ± 0,3 mm, angular ± 3°; max. speed 10.000 rpm, -10° to +80 °C, max. torque: 80 Ncm, material: fiber-glass reinforced polyamide, aluminum hub	KUP-0610-S	2056407
	Double loop coupling, shaft diameter 8 mm / 10 mm, max. shaft offset: radially +/- 0,25 mm, axially +/- 0,4 mm, angle +/- 4 degrees; max. speed 10.000 rpm, -30 to +120 degrees Celsius, torsional spring stiffness of 150 Nm/rad	KUP-0810-D	5326704
	Bar coupling, shaft diameter 8 mm / 10 mm, max. shaft offset: radial ± 0,3 mm, axial ± 0,3 mm, angular ± 3°; max. speed 10.000 rpm, -10° to +80 °C, max. torque: 80 Ncm, material: fiber-glass reinforced polyamide, aluminum hub	KUP-0810-S	5314178
	Bellows coupling, shaft diameter 10 mm/10 mm; maximum shaft offset: radial +/- 0.25 mm, axial +/- 0.4 mm, angular +/- 4°; max. revolutions 10,000 rpm, -30° to +120 °C, max. torque 80 Ncm; material: stainless steel bellows, aluminum clamping hubs	KUP-1010-B	5312983
	Double loop coupling, shaft diameter 10 mm / 10 mm, Maximum shaft offset: radial +/- 2.5 mm, axial +/- 3 mm, angular +/- 10°; max. speed 3,000 rpm, -30° to +80 °C, max. torque 1.5 Nm; material: polyurethane, galvanized steel flange	KUP-1010-D	5326703
	Spring washer coupling, shaft diameter 10 mm / 10 mm, maximum shaft offset, radial ± 0.3 mm, axial ± 0.4 mm, angle ± 2.5°, torsion spring stiffness 30 Nm/rad; material: aluminum flange, glass-fiber reinforced polyamide membrane and hardened steel coupling pin	KUP-1010-F	5312986
	Bar coupling, shaft diameter 10 mm / 10 mm; maximum shaft offset: radial ± 0.3 mm, axial ± 0.2 mm, angular ± 3°; speed 10,000 rpm, -10° to +80° Celsius, max. torque 80 Ncm; material: glass fiber-reinforced polyamide, aluminum hub	KUP-1010-S	2056408
	10 mm / 12 mm; maximum shaft offset: radial +/- 0.25 mm, axial +/- 0.4 mm, angular +/- 4°; max. revolutions 10,000 rpm, -30° to +120 °C, max. torque 80 Ncm; material: stainless steel bellows, aluminum clamping hubs	KUP-1012-B	5312984

	Brief description	Type	Part no.
	Double loop coupling, shaft diameter 10 mm / 12 mm, Maximum shaft offset: radial +/- 2.5 mm, axial +/- 3 mm, angular +/- 10°; max. speed 3,000 rpm, -30° to +80 °C, max. torque 1.5 Nm; material: polyurethane, galvanized steel flange	KUP-1012-D	5326702
Plug connectors and cables			
	Head A: female connector, JST, 8-pin, straight Head B: Flying leads Cable: Incremental, SSI, PUR, halogen-free, shielded, 5 m	DOL-0J08-G05MAA3	2046876
	Head A: female connector, JST, 8-pin, straight Head B: Flying leads Cable: Incremental, SSI, PUR, halogen-free, shielded, 0.5 m	DOL-0J08-G0M5AA3	2046873
	Head A: female connector, JST, 8-pin, straight Head B: Flying leads Cable: Incremental, SSI, PUR, halogen-free, shielded, 10 m	DOL-0J08-G10MAA3	2046877
	Head A: female connector, JST, 8-pin, straight Head B: Flying leads Cable: SSI, Incremental, PUR, halogen-free, shielded, 1.5 m	DOL-0J08-G1M5AA6	2048590
	Head A: female connector, JST, 8-pin, straight Head B: Flying leads Cable: SSI, Incremental, PUR, halogen-free, shielded, 3 m	DOL-0J08-G3M0AA6	2048591
	Head A: female connector, JST, 8-pin, straight Head B: male connector, M23, 12-pin, straight Cable: Incremental, PUR, halogen-free, shielded, 1 m	STL-2312-G01MAA3	2061622
	Head A: female connector, JST, 8-pin, straight Head B: male connector, M23, 12-pin, straight Cable: Incremental, PUR, halogen-free, shielded, 2 m	STL-2312-G02MAA3	2061504
	Head A: female connector, JST, 8-pin, straight Head B: male connector, M23, 12-pin, straight Cable: Incremental, PUR, halogen-free, shielded, 0.35 m	STL-2312-GM35AA3	2061621
	Head A: male connector, M12, 8-pin, straight, A-coded Head B: - Cable: Incremental, shielded	STE-1208-GA01	6044892
	Head A: male connector, M23, 12-pin, straight Head B: - Cable: HIPERFACE®, SSI, Incremental, shielded	STE-2312-G01	2077273
		STE-2312-GX	6028548

## SICK AT A GLANCE

SICK is one of the leading manufacturers of intelligent sensors and sensor solutions for industrial applications. A unique range of products and services creates the perfect basis for controlling processes securely and efficiently, protecting individuals from accidents and preventing damage to the environment.

We have extensive experience in a wide range of industries and understand their processes and requirements. With intelligent sensors, we can deliver exactly what our customers need. In application centers in Europe, Asia and North America, system solutions are tested and optimized in accordance with customer specifications. All this makes us a reliable supplier and development partner.

Comprehensive services complete our offering: SICK LifeTime Services provide support throughout the machine life cycle and ensure safety and productivity.

For us, that is “Sensor Intelligence.”

## WORLDWIDE PRESENCE:

Contacts and other locations –[www.sick.com](http://www.sick.com)